

10/7 Left Hand Double Turn

BASED ON A 16 TREAD STAIRCASE

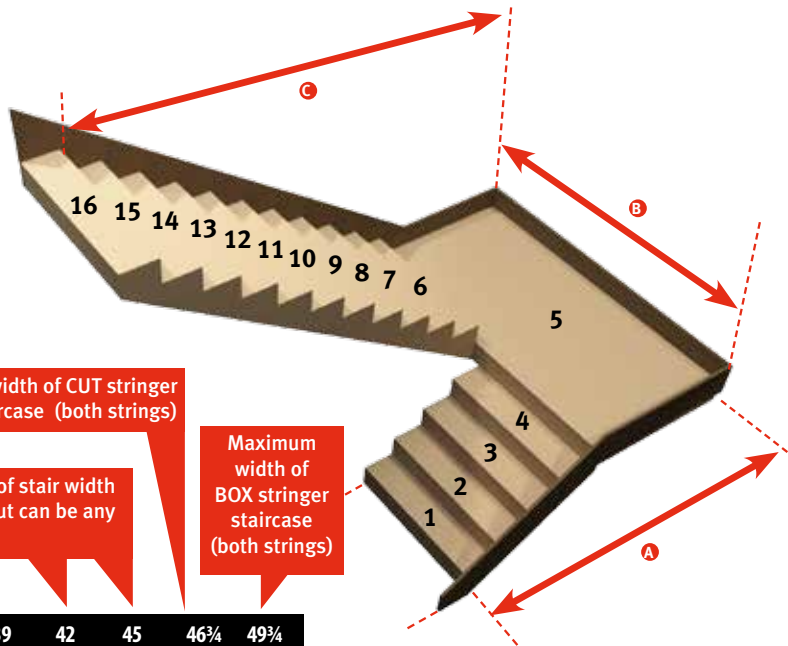

Maximum width of CUT stringer staircase (both strings)

Examples of stair width options (but can be any width)

Maximum width of BOX stringer staircase (both strings)

WIDTH	36	39	42	45	46¾	49¾
A	76¾	79¾	82¾	85¾	87½	90½
B	72	78	84	90	93½	99½
C	136¾	139¾	142¾	145¾	147½	150½

If you make your stairs 36" wide

Then your 'A' measurement will be 76" long

Then your 'B' measurement will be 72" long

And your 'C' measurement will be 136¾" long

ONE KIT DOES ALL:

Box string (Carpet ready) Box string (can be overlaid)
Cut string (Carpet ready) Cut string (can be overlaid)

10/7 LEFT HAND HALF TURN

BASED ON A 16 TREAD STAIRCASE

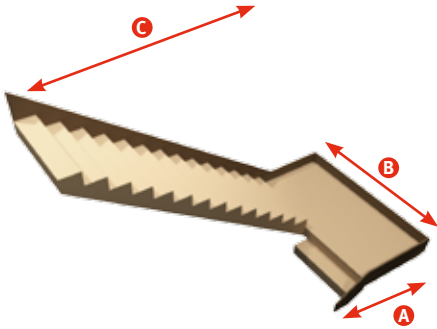

WIDTH	36"	39"	42"	45"	46¾"	49¾"
A	46¾"	49¾"	52¾"	55¾"	57½"	60½"
B	72	78	84	90	93½	99½
C	166¾	169¾	172¾	175¾	177½	180½

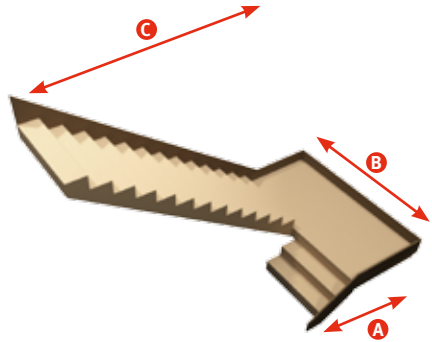

WIDTH	36"	39"	42"	45"	46¾"	49¾"
A	56¾"	59¾"	62¾"	65¾"	67½"	70½"
B	72	78	84	90	93½	99½
C	156¾	159¾	162¾	165¾	167½	170½

TO ADD OR MINUS A TREAD ALTER THE APPROPRIATE MEASUREMENT BY 10"

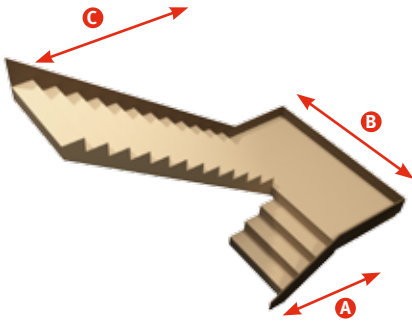

WIDTH	36	39	42	45	46¾	49¾
A	66¾	69¾	72¾	75¾	77½	80½
B	72	78	84	90	93½	99½
C	146¾	149¾	152¾	155¾	157½	160½

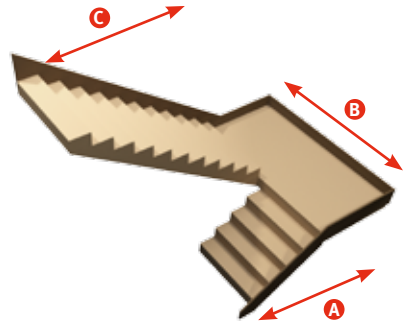

WIDTH	36	39	42	45	46¾	49¾
A	76¾	79¾	82¾	85¾	87½	90½
B	72	78	84	90	93½	99½
C	136¾	139¾	142¾	145¾	147½	150½

ONE KIT DOES ALL: Box string (Carpet ready) Box string (can be overlaid)
Cut string (Carpet ready) Cut string (can be overlaid)

10/7 LEFT HAND HALF TURN

BASED ON A 16 TREAD STAIRCASE

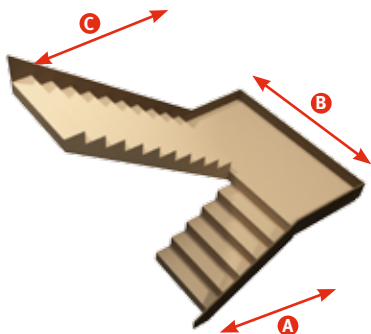

WIDTH	36"	39"	42"	45"	46¾"	49¾"
A	86¾"	89¾"	92¾"	95¾"	97½"	100½"
B	72"	78"	84"	90"	93½"	99½"
C	126¾"	129¾"	132¾"	135¾"	137½"	140½"

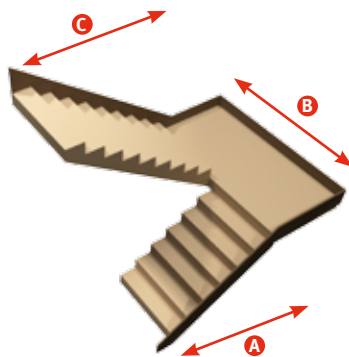

WIDTH	36"	39"	42"	45"	46¾"	49¾"
A	96¾"	99¾"	102¾"	105¾"	107½"	110½"
B	72"	78"	84"	90"	93½"	99½"
C	116¾"	119¾"	122¾"	125¾"	127½"	130½"

TO ADD OR MINUS A TREAD ALTER THE APPROPRIATE MEASUREMENT BY 10"

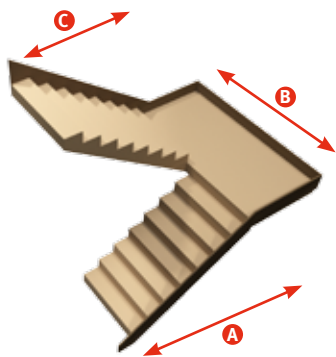

WIDTH	36	39	42	45	46¾	49¾
A	106¾"	109¾"	112¾"	115¾"	117½"	120½"
B	72"	78"	84"	90"	93½"	99½"
C	106¾"	109¾"	112¾"	115¾"	117½"	120½"

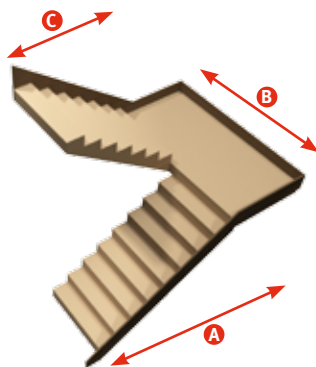

WIDTH	36	39	42	45	46¾	49¾
A	116¾"	119¾"	122¾"	125¾"	127½"	130½"
B	72"	78"	84"	90"	93½"	99½"
C	96¾"	99¾"	102¾"	105¾"	107½"	110½"

ONE KIT DOES ALL:

Box string (Carpet ready) Box string (can be overlaid)
Cut string (Carpet ready) Cut string (can be overlaid)

10/7 LEFT HAND HALF TURN

BASED ON A 16 TREAD STAIRCASE

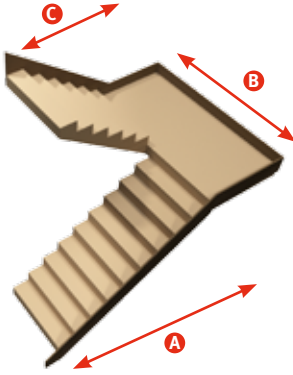

WIDTH	36"	39"	42"	45"	46¾"	49¾"
A	126¾"	129¾"	132¾"	135¾"	137½"	140½"
B	72"	78"	84"	90"	93½"	99½"
C	86¾"	89¾"	92¾"	95¾"	97½"	100½"

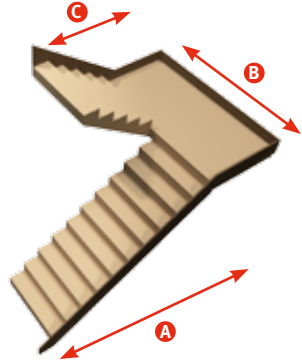

WIDTH	36"	39"	42"	45"	46¾"	49¾"
A	136¾"	139¾"	142¾"	145¾"	147½"	150½"
B	72"	78"	84"	90"	93½"	99½"
C	76¾"	79¾"	82¾"	85¾"	87½"	90½"

TO ADD OR MINUS A TREAD ALTER THE APPROPRIATE MEASUREMENT BY 10"

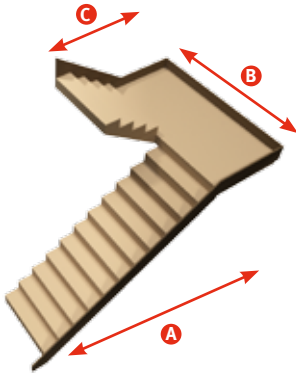

WIDTH	36	39	42	45	46¾	49¾
A	146¾"	149¾"	152¾"	155¾"	157½"	160½"
B	72	78	84	90	93½	99½
C	66¾"	69¾"	72¾"	75¾"	77½"	80½"

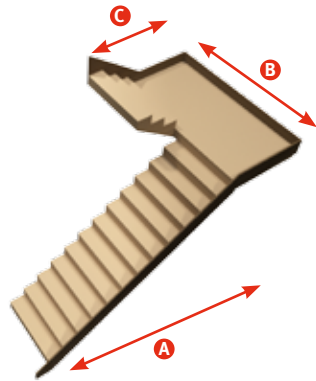

WIDTH	36	39	42	45	46¾	49¾
A	156¾"	159¾"	162¾"	165¾"	167½"	170½"
B	72	78	84	90	93½	99½
C	56¾"	59¾"	62¾"	65¾"	67½"	70½"

ONE KIT DOES ALL:

Box string (Carpet ready) Box string (can be overlaid)
Cut string (Carpet ready) Cut string (can be overlaid)

10/7 LEFT HAND HALF TURN

BASED ON A 16 TREAD STAIRCASE

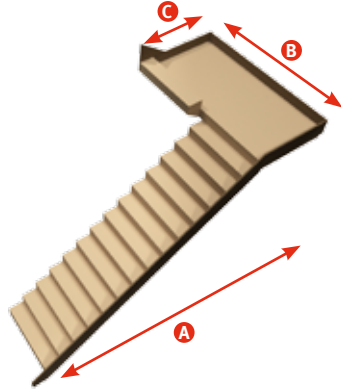
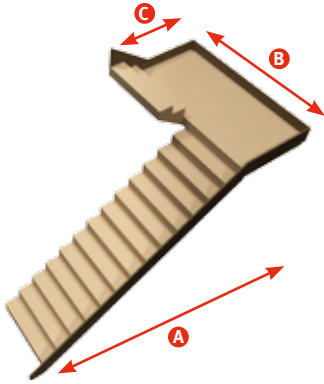

WIDTH	36"	39"	42"	45"	46¾"	49¾"
A	166¾"	169¾"	172¾"	175¾"	177½"	180½"
B	72"	78"	84"	90"	93½"	99½"
C	46¾"	49¾"	52¾"	55¾"	57½"	60½"

WIDTH	36"	39"	42"	45"	46¾"	49¾"
A	176¾"	179¾"	182¾"	185¾"	177½"	190½"
B	72"	78"	84"	90"	93½"	99½"
C	36"	39"	42"	45"	46¾"	49¾"

TO ADD OR MINUS A TREAD ALTER THE APPROPRIATE MEASUREMENT BY 10"

PLEASE NOTE

If you need 17 treads (including the nosing) then your stair size will be 10" larger than the ones in this catalogue and so on. If you only need 15 treads (including nosing) then your stair size will be 10" smaller than the ones in this catalogue and so on.

IMPORTANT

Depending on your floor to floor measurement and stair design when incorporating a landing you may need to add another KwikStairs kit to achieve your chosen design.

ONE KIT DOES ALL

ANY WIDTH
UP TO 49¾"



BOX STRING - carpet Ready

ANY WIDTH
UP TO 46¾"



CUT STRING - carpet ready

ANY WIDTH
UP TO 49¾"



BOX STRING - can be overclad

ANY WIDTH
UP TO 46¾"



CUT STRING - can be overclad